

IT EN FR ES P D NL PL GR RUS

WINDOW HINGE

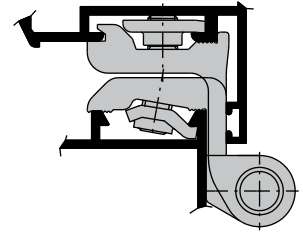
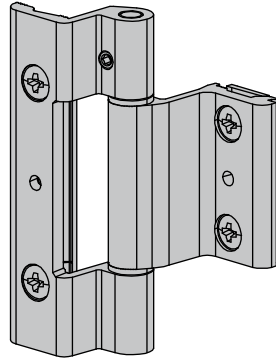

**fapim**<sup>®</sup>

Life in evolution



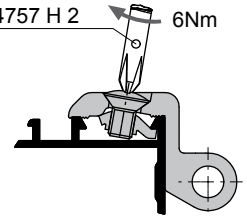
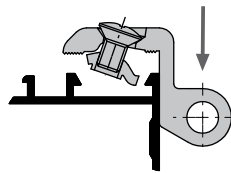
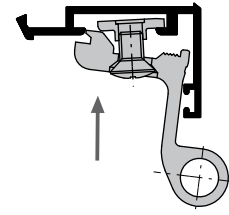
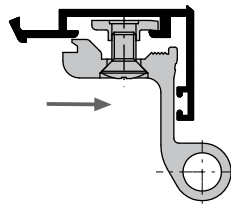
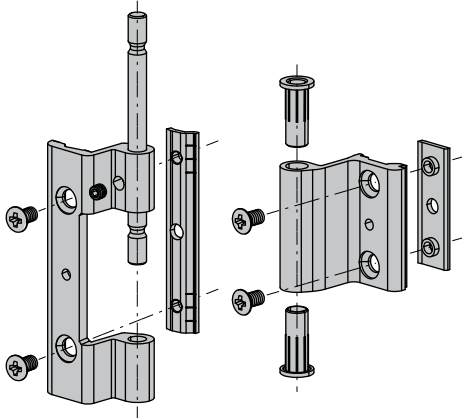



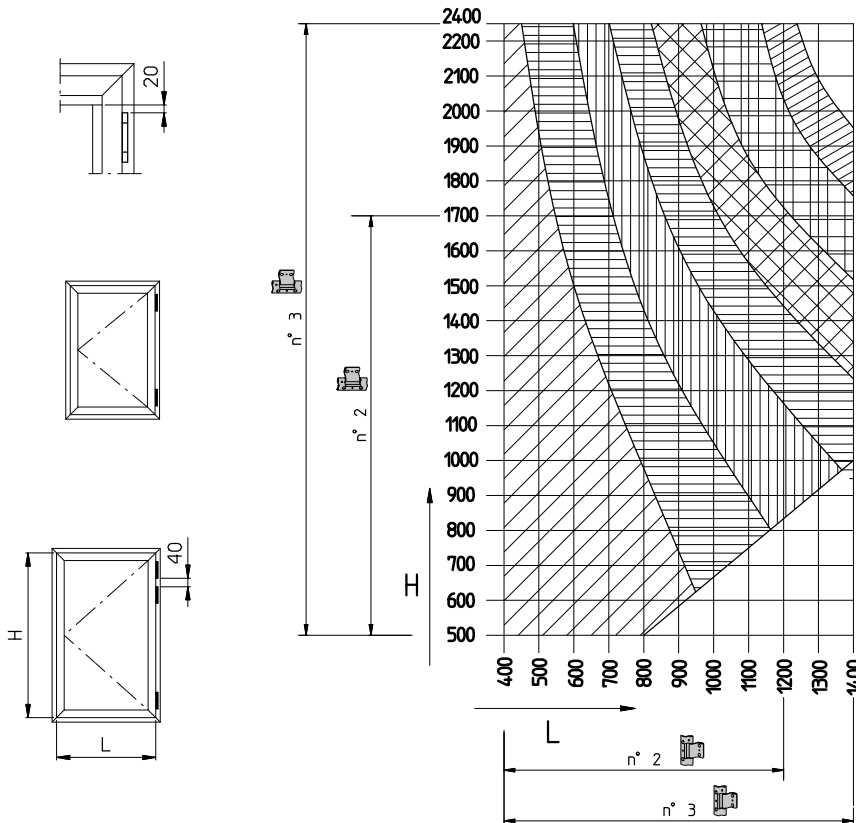

ULDK - Rev.00



UNI EN ISO 4757 H 2 6Nm

LIMITI D'USO LIMIT OF UTILIZATION LIMITE DE UTILIZATION BENUTZUNGSGRENZE LIMITACION DE UTILIZACION  
GEBRUIZSLIMIET LIMITES À UTILIZAÇÃO ORGANICZENIA ZASTOSOWANIA ΠΕΡΙΟΡΙΣΜΟΙ ΧΡΗΣΗΣ



	Kg/m <sup>2</sup>	N° 
	20	n° 3
	30	n° 3
	20	n° 2
	40	n° 3
	30	n° 2
	50	n° 3
	40	n° 2
	60	n° 3
	50	n° 2
	70	n° 3
	60	n° 2
	80	n° 3
	70	n° 2